

Volute Casing Pump with Radial Impeller



These Operating Instructions Contain Fundamental Information & Precautionary Notes. Please Read The Manual Thoroughly Prior To Installation Of Unit, Electrical Connection & Commissioning. It Is Imperative To Comply With All Other Operating Instructions Referring To Components Of Individual Units.

Contents	Page
1 General	4
2 Safety	5
2.1 Marking of Instructions in the Manual	5
2.2 Personnel Qualification and Training	5
2.3 Non-compliance with Safety Instructions	6
2.4 Safety Awareness	6
2.5 Safety Instructions for the Operator / User	6
2.6 Safety Instructions for Servicing, Inspection and Installation Work	6
2.7 Unauthorised Modification and Manufacture of Spare Parts	6
2.8 Impermissible Modes of Operation	6
3 Transport and Interim Storage	7
3.1 Safety Instructions	7
3.2 Transport	7
3.3 Lifting and Transport of the Pump Unit by Crane	7
3.4 Interim storage	7
4 Description of the Product and Accessories	8
4.1 Technical Specification	8
4.2 Design Details	8
4.2.1 Pump Casing	8
4.2.2 Impeller	8
4.2.3 Pump Shaft	8
4.2.4 Shaft seal	8
4.2.5 Bearings and Lubrication	8
4.3 Accessories	8
4.4 Dimensions and Weights	8
5 Installation at Site	9
5.1 Safety Regulations	9
5.2 Checks to Be Carried Out Prior to Installation	9
5.3 Installing the Pump / Unit	9
5.4 Connecting the Piping	9
5.5 Flushing Pipe	10
5.6 Auxiliary Connections	10
5.7 Coupling Guard	10
5.8 Final Check	10
6 Commissioning, Start-up/ Shutdown	11
6.1 Commissioning	11
6.2 Shaft Seal	11
6.3 Venting	11
6.4 Commissioning	11
6.4.1 Checking the Direction of Rotation	11
6.4.2 Start-up	12
6.4.3 Pump Operating Range	12
6.4.4 Shutdown	12
6.5 Shutdown / Storage / Preservation	13
6.5.1 Storage of New Pumps	13
6.5.2 Measures to Be Taken for Prolonged Shutdown	13
6.6 Returning to Service after Storage	13
7 Servicing / Maintenance	14
7.1 General Instructions	14
7.2 Servicing / Inspection	14
7.2.1 Supervision of Operation	14
7.2.2 Servicing of the Shaft Seal	14
7.2.3 Servicing of the Bearings	14
7.3 Dismantling	16
7.3.1 Fundamental Instructions and Recommendations	16

7.3.2 Dismantling	16
7.4 Reassembly	17
7.5 Instructions for Replacement of Assemblies / Parts	19
7.5.1 Replacing the Shaft Seal	19
7.5.2 Replacing the Casing Wear Rings and / or Impeller Wear Rings	19
7.6 Routine Servicing and Inspection Intervals	20
7.7 Supervision Plan	21
7.8 Spare Parts	22
7.8.1 Purchasing of Spare Parts	22
7.8.2 Spare Parts Stock	22
8 Trouble-shooting	23
8.1 General	23
8.2 Causes of Faults and Their Remedies	24
9 Relevant Documentation	Annex

1 General

This PUMPIRAN pump has been developed in accordance with state-of-the-art technology, it is manufactured with utmost care and subject to continuous quality control.

These operating instructions are intended to facilitate familiarisation with the pump and its designated use.

The manual contains important information for reliable, proper and efficient operation. Compliance with the operating instructions is of vital importance to ensure reliability and a long service life of the pump and to avoid any risks.

These operating instructions do not take into account local regulations; the operator must ensure that such regulations are strictly observed by all, including the personnel called in for installation.



This pump/unit must not be operated beyond the limit values specified in the technical documentation for the medium handled, capacity, speed, density, pressure, temperature and motor rating. Make sure that operation is in accordance with the instructions laid down in this manual or in the contract documentation.

The name plate indicates the type series/size, main operating data and works / serial number ; please quote this information in all queries, repeat orders and particularly when ordering spare parts. If you need any additional information or instructions exceeding the scope of this manual or in case of damage please contact PUMPIRAN's nearest customer service centre.

2 Safety

These operating instructions contain fundamental information which must be complied with during installation, operation and servicing. Therefore this operating manual must be read and understood both by the installing personnel and the responsible trained personnel/operators prior to installation and commissioning, and it must always be kept close to the location of operation of the machine/unit for easy access. Not only must the general safety instructions laid down in this chapter on "Safety" be complied with, but also the safety instructions outlined under specific headings.

2.1 Marking of Instructions in the Manual

Symbol	Description
	The safety instructions contained in this manual whose non-observance might cause hazards to persons are specially marked with the general hazard sign, namely Safety sign in accordance with DIN 4844 - W9.
	The electrical danger warning sign Safety sign in accordance with DIN 4844 - W8.
	is used to introduce safety instructions whose nonobservance may lead to damage to the machine and its functions.

Instructions attached directly to the machine, e.g.

- arrows indicating the direction of rotation
- markings for fluid connections

Must always be complied with and be kept in perfectly legible condition at all times.

2.2 Personnel Qualification and Training

All personnel involved in the operation, servicing, inspection and installation of the machine must be fully qualified to carry out the work involved. Personnel responsibilities, competence and supervision must be clearly defined by the operator. If the personnel in question is not already in possession of the requisite know-how, appropriate training and instruction must be provided. If required, the operator may commission the manufacturer/supplier to take care of such training.

In addition, the operator is responsible for ensuring that the contents of the operating instructions are fully understood by the responsible personnel.

2.3 Non-compliance with Safety Instructions

Non-compliance with safety instructions can jeopardise the safety of personnel, the environment and the machine itself. Non-compliance with these safety instructions will also lead to forfeiture of any and all rights to claims for damages.

In particular, non-compliance can, for example, result in:

- failure of important machine/unit functions
- failure of prescribed servicing and maintenance practices
- hazard to persons by electrical, mechanical, chemical and thermal effects
- hazard to the environment due to leakage of hazardous substances.

2.4 Safety Awareness

It is imperative to comply with the safety instructions contained in this manual, the relevant national health and safety regulations and the operator's own internal work, operation and safety regulations.

2.5 Safety Instructions for the Operator /User

- Any hot or cold components that could pose a hazard must be equipped with a guard by the operator.
- Guards which are fitted to prevent accidental contact with moving parts (e.g. coupling) must not be removed whilst the machine is operating.
- Leakages (e.g. at the shaft seal) of hazardous media handled (e.g. explosive, toxic, hot) must be contained so as to avoid any danger to persons and the environment. Pertinent legal provisions must be adhered to.
- Electrical hazards must be eliminated. (In this respect refer to the relevant safety regulations applicable to different countries and/or the local energy supply companies.)

2.6 Safety Instructions for Servicing, Inspection and Installation Work

The operator is responsible for ensuring that all servicing, inspection and installation work be performed by authorised, qualified specialist personnel who are thoroughly familiar with the manual.

Work on the machine must be carried out only during standstill. The shutdown procedure described in the manual for taking the machine out of service must be adhered to without fail.

Pumps or pump units handling media injurious to health must be decontaminated.

Immediately following completion of the work, all safety-relevant and protective devices must be reinstalled and/or re-activated.

Please observe all instructions set out in the chapter 6.1 on "Commissioning" before returning the machine to service.

2.7 Unauthorised Modification and Manufacture of Spare Parts

Modifications or alterations of the machine are only permitted after consultation with the manufacturer. Original spare parts and accessories authorised by the manufacturer ensure safety. The use of other parts can invalidate any liability of the manufacturer for consequential damage.

2.8 Impermissible Modes of Operation

The warranty relating to the operating reliability and safety of the pump/unit supplied is only valid if the machine is used in accordance with its designated use and if all operating instructions described in chapter 1 have been followed. The limits stated in the data sheet must not be exceeded under any circumstances.

3 Transport and Interim Storage

3.1 Safety Instructions

	WARNING
	Transport of the unit requires proper preparation and handling. Observe the following explanations and safety instructions

3.2 Transport

Transport in horizontal position is recommended in all cases, since this ensures stable positioning of the unit without any risk of accident, whatever the method of transport is, e.g. road, rail or ship, etc.

For transport purposes the unit should be secured on suitable pallets or sleds. All loose and movable parts must be secured.

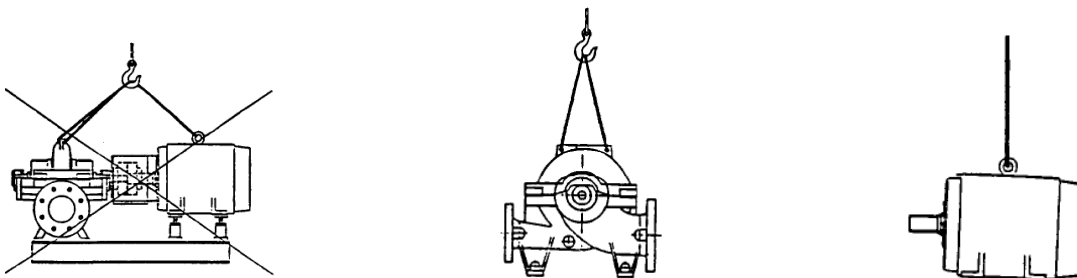

3.3 Lifting and Transport of the Pump Unit by Crane

	WARNING
	The motor lifting lugs may only be used for lifting the motor alone and never for lifting the complete unit.

When a crane is used to lift or transport the unit, pay attention to the angle of spread of the lifting equipment (ropes, belts).

Avoid angles of more than 90 °!

Use separate belts on each side!

The diagrams on the right show how to correctly lift and transport the unit by crane.

3.4 Interim storage

Please observe the instructions set out in the chapter 6.5 “Shutdown / Storage / Preservation”

4 Description of the Product and Accessories

4.1 Technical Specification

The PUMPIRAN pump of the DSP type series is a horizontally installed, single-stage, axially split volute casing pump with double-entry radial impeller. Connecting flanges are manufactured on option to ISO, DIN EN, or ASME. DSP is designed for use in waterworks, irrigation and drainage pumping stations, power stations, industrial water supply systems, shipbuilding as well as general petrochemical applications.

4.2 Design Details

4.2.1 Pump Casing

Axially split volute casing with replaceable casing wear rings.

Suction and discharge nozzles in the lower casing half are at the same level (in-line design).

4.2.2 Impeller

The double-entry radial impeller is manufactured for the individual operating data; including wear rings, if requested.

In double-entry radial impellers the axial thrust is largely balanced.

4.2.3 Pump Shaft

The shaft is fully sealed against the medium pumped. Shaft protecting sleeves are fitted in the seal area.

4.2.4 Shaft seal

The shaft is sealed on the driven and non-driven ends by a gland packing or by a balanced mechanical seal that is independent of the direction of rotation.

The gland packing mounted on PUMPIRAN pumps are asbestos-free and suitable for drinking water applications. For a description of the mechanical seal, see section 9.5.

4.2.5 Bearings and Lubrication

The pump is fitted on either side with grease lubricated or oil-lubricated (optional) rolling element bearings. The locating bearing is situated on the driven end.

4.3 Accessories

The accessories supplied with the pump are specified in the relevant individual operating instructions in chapter 9.

4.4 Dimensions and Weights

For dimensions and weights please refer to the installation drawing in section 9.1.

5 Installation at Site

5.1 Safety Regulations

	DANGER
	<p>Electrical equipment operated in hazardous locations of the zone 1 must comply with the explosion protection regulations. This is indicated on the motor rating plate.</p> <p>If the equipment is installed in hazardous locations, the applicable local explosion protection regulations and the regulations of the test certificate supplied with the equipment and issued by the responsible approval authorities must be observed and complied with. The test certificate must be kept close to the location of operation for easy access (e.g. foreman's office).</p>

5.2 Checks to Be Carried Out Prior to Installation

All structural work required must have been prepared in accordance with the dimensions stated in the installation drawing. The concrete foundations shall have sufficient strength (min. BN 150) to ensure safe and functional installation in accordance with DIN 1045 or equivalent standards.

Make sure that the concrete foundation has set firmly before placing the unit on it. Its surface should be truly horizontal and even.

5.3 Installing the Pump / Unit

	Caution
	<p>Prior to installing the pump, check the operating data. check the data on the name plate for compliance with the data in the purchase order and the system data, e.g. operating voltage, frequency, medium temperature, etc.</p>

The installation drawing in section 9.1 must be observed.

Prior to installation, the personnel involved must be informed on the local safety regulations by the site management.

For all work mentioned below, the pump must be set up safely and secured as required.

Place the levelling spindles included in the scope of supply beside the foundation bolt recesses as shown in the installation drawing. Then place the baseplate with the foundation bolts inserted onto the levelling spindles and align it with their help.

Place the pump and motor onto the baseplate and align their shafts in relation to each other.

Grout the recesses for the foundation bolts with quick-setting concrete. When the concrete has set, tighten the foundation bolts until the nuts fit tightly to the baseplate.

Lift the pump and motor off the baseplate.

Grout the baseplate with concrete. Make sure the baseplate is completely filled and no cavities remain.

When the concrete has set, tighten the foundation bolts uniformly. The tightening torque is given in the installation drawing in section 9.1.

After tightening of the foundation bolts, mount the pump and motor on the baseplate and align their shafts in relation to each other.

	Caution
	<p>Observe the operating instructions for the coupling.</p>

The run-out between pump shaft and motor shaft shall be smaller than 0.05 mm. Faulty alignment can destroy the transmission elements of the coupling and the bearings of motor and pump. In addition, check whether the direction of rotation corresponds to the direction indicated by the arrow on the pump casing.

5.4 Connecting the Piping

	Caution
	<p>Never use the pump itself as an anchorage point for the piping. Suction lift lines should be laid with a rising slope towards the pump and suction headlines with a downward slope towards the pump. The pipelines should be anchored in close proximity to the pump and should be connected without transmitting any stresses or strains. Their weight must not exert any load on the pump. With short pipelines, the nominal diameters should be at least equal to the nominal diameters of the pump nozzles. For long pipelines the most economical nominal diameter has to be determined from case to case.</p>

Any additional loads on the discharge and suction nozzles, e.g. caused by the weight of the water-filled pipes, changes in the length of pipes owing to temperature fluctuations, reaction forces due to unbraced expansion joints must not exceed the values stated in the installation drawing.

	WARNING
	An excessive, impermissible increase in the pipeline forces may cause leaks on the pump where the medium handled can escape into the atmosphere.

Danger of life when hot media are handled!

Furthermore, impermissibly high forces and moments acting on the nozzles may impair the alignment of the pump set and cause damage to the coupling, bearings or shafts.
The flange covers on the pump suction and discharge nozzles must be removed prior to installation in the piping.

5.5 Flushing Pipe

The pump has been equipped with a flushing pipe at the factory.
Usually we supply this assembly completely mounted on the pump. Should this, however, not be the case, mount the hoses and fittings as shown on the attached drawing.

5.6 Auxiliary Connections

The dimensions and locations of the auxiliary connections (cooling, heating, sealing liquid, flushing liquid, etc.) are indicated on the installation drawing in section 9.1.
More detailed installation instructions are given in the respective operating instructions for the accessories.
These connections are required for proper functioning of the pump and, therefore, are of paramount importance!

5.7 Coupling Guard

	WARNING
	In compliance with the accident prevention regulations the pump must not be operated without a coupling guard. If the customer specifically requests not to include a coupling guard in our delivery, then the operator must supply one.

5.8 Final Check

Re-check the alignment of the pump set. It must be easy to rotate the shaft by hand by means of the coupling.
Check the integrity and proper functioning of all connections.

6 Commissioning, Start-up/ Shutdown

	Caution
	Compliance with the following requirements is of paramount importance. Damage resulting from non-compliance shall not be covered by the scope of warranty.

6.1 Commissioning

Before starting up the pump make sure that the following requirements have been checked and fulfilled:

- The pump has been firmly bolted to the baseplate/foundation?
- The coupling or pump unit have been aligned as specified?
- The pipes have been properly fitted?
- The motor has been installed according to its operating instructions?
- The unit can be easily rotated by hand at the coupling? (Carry out at least one full rotation)
- The coupling guard has been fitted?
- The staff have been informed about sources of danger and measures to be taken to comply with the accident prevention regulations?
- The unit is protected against overload (appropriate safety valve)?
- The seals have been mounted correctly? (For gland packing, see section 7.4, for mechanical seals, see section 9.5 of these operating instructions).
- Additional devices, if any, have been prepared and fitted according to their operating instructions?
- The rolling element bearings have been packed with grease or (if applicable) the constant-level oilers have been mounted and filled with oil? (See section 7.2.3)
- The pump has been vented as specified in section 6.3.?

6.2 Shaft Seal Mechanical Seal

For putting the shaft seal into operation, refer to the operating instructions of the mechanical seal in section 9.5.

Gland Packing

Commission the pump with the gland no tighter than finger-tight. A high, initial leakage rate – in keeping with the medium pumped – is acceptable (approx. 50 to 200 drops per minute) until the packing material has settled and become adjusted to the working temperature (after approx. 30 minutes). After running-in the packing material, reduce the leakage rate to a very slight drip by tightening the gland further carefully and evenly. Do not stop the leakage altogether, as this would cause the gland packing to become hot.

N. B.:

If the leakage is accompanied by a build-up of heat: switch off the pump, if necessary. Let the pump cool down (for approx. 10 to 15 minutes), then repeat the start-up procedure. The required minimum leakage rate depends on the pressure, slip velocity and temperature of the medium pumped. It should be in the range of approx. 10 to 120 drops per minute (20 drops of water correspond to approximately 1 ml).

6.3 Venting

Before start-up, the pump and the pipes must be vented and primed with the liquid to be pumped. For this purpose, use the vent plug or the vent valve (option) at the top of the volute casing; in the case of suction lift operation, the pump must be evacuated additionally.

6.4 Commissioning

6.4.1 Checking the Direction of Rotation

	<p>Caution</p> <p>For trouble-free operation of the pump, the correct direction of rotation of the impeller is of paramount importance. If running in the wrong direction of rotation, the pump cannot reach its duty point; vibrations and overheating will be the consequence. The pump set or the shaft seal might be damaged.</p>
---	--

Correct Direction of Rotation

The direction of rotation must correspond to the direction indicated by the arrow on the pump. This can be verified by switching the pump on and then off again immediately.

	WARNING
	<p>Before checking the direction of rotation make sure that there is no foreign matter in the pump casing. Never put your hands or any other objects into the pump!</p>

6.4.2 Start-up

	Caution
	<ul style="list-style-type: none"> • Dry-running will result in increased wear and must be avoided. • If no non-return valve is fitted on the discharge side, close the discharge gate valve. • Fully open the suction-side shut-off element, if installed. • All additional connections for cooling, heating, lubrication, flushing or sealing liquid, etc., if applicable, must be opened fully or switched on, and the through flow must be checked. • Switch on the motor. • As soon as the pump starts to deliver – that means when the discharge pressure at the gauge rises - slowly open the discharge gate valve fully.

	Caution
	<p>The pump may be operated against a closed discharge gate valve only during the start-up and shutdown phase, as otherwise impermissible temperature increases occur, which lead to damage.</p>

6.4.3 Pump Operating Range

The flow rate "Q" as a function of the discharge head is achieved automatically in accordance with the Q/H curve. The permissible pump operating range is subject to limits having causes that are independent of each other.

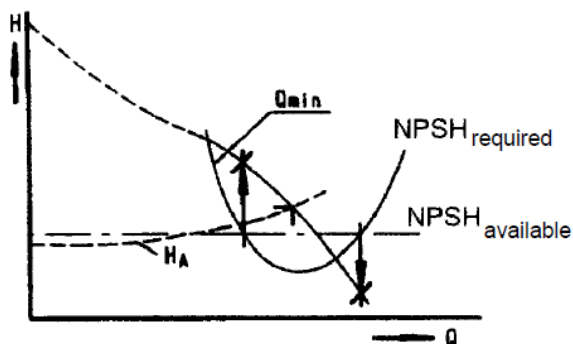

1. Part-load operating limit at a low flow rate.

This limit is indicated in the Q/H curve by Q_{min} or by the continuation of the characteristic curve which is not depicted.

	Caution
	<p>It is not permitted to operate the pump in the range from $Q = 0$ to Q_{min}. Prolonged operation in this range causes greatly increasing mechanical loads which the components cannot withstand. Brief passing through the critical range, e.g. during start-up, is permitted</p>

2. NPSH-induced limits in the part-load and overload ranges

These two limits are based on the ratio of **NPSH_{required}** to **NPSH_{available}**. They are determined as follows: The intersections of **NPSH_{required}** and **NPSH_{available}** are projected to the Q/H curve, where they produce the operating limits (refer to the diagram). Checking of the NPSH-induced operating limit is not necessary for operating the pump under design conditions. If system-induced changes occur, an NPSH check must be carried out. If necessary, consult PUMPIRAN's nearest customer service centre.

6.4.4 Shutdown

Close the shut-off element in the discharge line. If the discharge line is equipped with a check valve, the shut-off element may remain open, provided there is back pressure in the line.

	WARNING
	<p>The shut-off element in the suction line must not be closed when switching off the pump. Switch off the motor, making sure that the unit runs smoothly down to a standstill. In the case of prolonged shutdown, the shut-off element in the suction line has to be closed. Close the auxiliary connections. The shaft seal in pumps where the liquid is fed in under vacuum must also be lubricated with sealing liquid during standstill. In the event of frost risk and/or prolonged shutdowns, the pump – and if applicable the cooling chambers - must be drained or otherwise protected against freezing.</p>

6.5 Shutdown / Storage / Preservation

Each PUMPIRAN pump leaves the factory carefully assembled. If commissioning is to take place sometime after delivery, we recommend that the following measures be taken for pump storage.

6.5.1 Storage of New Pumps

- New pumps are supplied by our factory duly prepared for storage. Maximum protection for up to 12 months, if the pump is properly stored indoors.
 - Store the pump in a dry and vibration-free location.
 - Rotate the pump shaft by hand once a month to prevent the rolling element bearings from being damaged.
- Should there be a risk of humidity condensation inside the pump, replace the lubricant fill of the bearings and check the condition of the rolling element bearings prior to commissioning.

6.5.2 Measures to Be Taken for Prolonged Shutdown

1. The pump remains installed; periodic check of operation

In order to make sure that the pump is always ready for instant start-up and to prevent the formation of deposits within the pump and the pump intake area, start up the pump set once a month or once every 3 months for a short time (approx. 5 minutes) during prolonged shutdown periods. Prior to an operation check run ensure that there is sufficient liquid available for operating the pump.

2. The pump is removed from the pipe and stored

Before putting the pump into storage carry out all checks specified in sections 7.1 to 7.4. Then apply appropriate preservatives.

Spray-coat the inside wall of the pump casing, and in particular the impeller clearance areas, with a preservative. Spray the preservative through the suction and discharge nozzles. It is advisable to close the nozzles (for example with plastic caps).

6.6 Returning to Service after Storage

Before returning the pump to service carry out all checks and servicing work specified in sections 7.1 and 7.2.

	WARNING
	In addition, the instructions laid down in sections 6.1 "Commissioning" and 6.4.3 "Pump Operating Range" must be observed

	WARNING
	Upon completion of the work, all safety related and protective equipment must be properly refitted and/or reactivated before starting the pump set.

7 Servicing / Maintenance

7.1 General Instructions

The operator is responsible for ensuring that all servicing, inspection and installation work is carried out by authorised, duly qualified staff who are thoroughly familiar with these operating instructions. A regular servicing schedule will help avoid expensive repairs and contribute to trouble-free, reliable operation of the pump with a minimum of servicing expenditure and work.



	DANGER
	Work on the unit may only be carried out with the electrical connections disconnected. Make sure that the pump set cannot be switched on accidentally (danger of life!).

	WARNING
	Pumps handling liquids posing health hazards must be decontaminated. When draining the medium see to it that there is no risk to persons or the environment. All relevant laws must be adhered to (danger of life!).

7.2 Servicing / Inspection

7.2.1 Supervision of Operation

	Caution
	The pump should run quietly and free from vibrations at all times. The pump must never be allowed to run dry.

	<p>WARNING</p> <p>Prolonged operation against a closed shut-off element is not permitted in order to prevent the medium handled from heating up. At room temperatures of up to 30 °C (86 °F) the bearing temperature should not exceed 90 °C (194 °F). At higher room temperatures, the bearing temperature should be below 100 °C (212 °F). With oil-lubricated bearings, the correct oil level must be checked at regular intervals.</p>
	<p>WARNING</p> <p>During pump operation the shut-off element in the inlet line must not be closed. Any stand-by pumps installed should be switched on and then immediately off again once a week to keep them operational. Attention should be paid to the correct functioning of the auxiliary connections.</p>
	<p>Caution</p> <p>If the flexible coupling elements begin to show signs of wear, they should be replaced in due time. See operating instructions of the drive coupling in section 9.3. If the liquid for sealing, cooling and lubricating is taken from an external source, the pressure must be 1.0 to 2.0 bar higher than at the suction nozzle.</p>

7.2.2 Servicing of the Shaft Seal

Service the mechanical seal as outlined in section 9.5 of the manual.

Gland packing have to be packed with fresh packing material as described in section 7.4 of this manual after each extended period of standstill, after each repair and as a remedy against an excessive leakage rate. It is, therefore, recommended to observe the leakage rate whilst the pump is in operation, also to stop the gland becoming hot.

7.2.3 Servicing of the Bearings

7.2.3.1 Grease-lubricated Bearings

The rolling element bearings have been packed with grease at the factory. Bearings and grease fill have to be checked prior to commissioning/start-up. If there is reason to suspect that shipment and/or storage may have resulted in dirt or condensed water collecting in the bearing, or that the grease has become resinous or that it has run out, the bearing has to be filled with a new supply of grease before commissioning/start-up of the pump. In addition, the grease has to be changed each time the bearing is dismantled/re-assembled, at the latest after two years.

Before packing the bearing with fresh grease, clean the bearing itself, the bearing housing and bearing cover with benzene, benzene or similar, and remove all of the washing agent when finished. Fill the hollow spaces between the rolling elements of the bearings to capacity and the bearing covers approximately half-way with grease, taking care to observe the greatest possible cleanliness.

The bearing is re-lubricated with a grease gun by means of the lubricating nipples at the bearing covers. Use a high-quality, lithium soap-based bearing grease that is free from resin or acid, is not liable to crumble, and has good rust-preventive characteristics. The grease should have a penetration number between 2 and 3, which corresponds to a worked penetration between 220 and 295 mm/10. The drop point should not be below 175°C. Lubricating intervals, lubricant quantities as well as the recommended type of grease are indicated in the technical data of the pump in section 9.2.

Re-lubrication is only allowed with the pump in operation.

7.2.3.2 Oil-lubricated Bearings

A constant-level oiler is provided on each bearing housing of the pump.

Function of Constant-level Oiler

When the oil level in the bearing falls, the oil level in the connection elbow supplying oil to the bearing falls as well. This decrease in the oil level uncovers the opening of the angular-cut pipe, and air enters the oil reservoir. Consequently, a corresponding quantity of oil can flow from the oil reservoir through the pipe to the bearing housing, re-establishes the predetermined oil level and covers the opening of the angular-cut pipe again.

	Caution
	<p>This process is repeated as often as the oil level in the bearing housing drops – until the oil reservoir is empty. The oil level can be easily checked through the transparent oil reservoir.</p> <p>The constant-level oilers must be fitted and filled with oil prior to commissioning/start-up.</p>

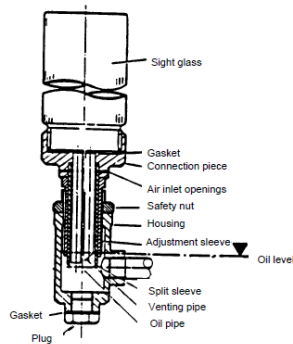

Constant-level oiler

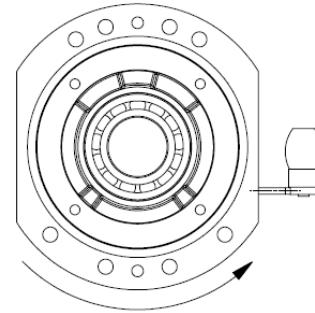



Installation position of constant-level oiler

The constant-level oiler shall be mounted depending on the direction of rotation as shown in the figure above. The opposite hole shall be closed with a plug.

Filling the constant-level oiler

Slacken the safety nut at the constant-level oiler, draw out the oil reservoir of the constant-level oiler and fill the reservoir of the constant-level oiler with oil.

	Caution
	<p>Re-insert the oil reservoir of the constant-level oiler and lock it.</p> <p>As a general rule, oil should only be topped up with the pump not being in operation. Should it be unavoidable to top up the oil of the constant-level oiler when the pump is in operation, a temporary oil leakage might occur. After a short time check whether the oil level in the reservoir has dropped. At least one third of the reservoir must be filled with oil. If this oil level is underrun, top up with oil.</p>

	Caution
	<p>The oil level must always be below the vent opening arranged at the top edge of the connection elbow! Make sure the opening is always perfectly dry!</p>

Oil Change Intervals

In order to ensure a long service life of the rolling element bearings, the oil must be changed at the following intervals:

1. Oil change after 300 operating hours
2. Oil change after 2000 operating hours
3. All subsequent oil changes after every 8000 operating hours, at least once a year.

The bearings must be cleaned thoroughly on every oil change.

	Caution
	Always use clean oil!

Trouble

- a) Oil reservoir empties, oil level in the bearing housing rises.

Possible cause

Seal of oil reservoir is defective (air ingress).

- b) Oil level in bearing housing falls, no oil follows from the oil reservoir.

Possible cause

Vent opening at the connection elbow is clogged.

7.3 Dismantling

	WARNING
	<p>Before dismantling, secure the pump so as to make sure it cannot be switched on accidentally. The shut-off elements in the suction and discharge lines must be closed. The pump must have cooled down to ambient temperature, it must be drained and its pressure must be released.</p> <p>Dismantling and reassembly must always be carried out in accordance with the relevant sectional drawing.</p>

7.3.1 Fundamental Instructions and Recommendations

Repair and servicing work on the pump must only be carried out by specially trained personnel, using original spare parts.

Observe the safety regulations laid down. Any work on the motor shall be governed by the specifications and regulations of the respective motor supplier.

Dismantling and reassembly must always be carried out in accordance with the relevant sectional drawing. The sectional drawing and other relevant documents are found in the annex. The dismantling sequence can be derived from the sectional drawing.

In case of damage you can always contact our service departments.

7.3.2 Dismantling

	Caution
	Observe the operating instructions of the coupling.

The pump is designed so that the complete rotor can be removed in the sequence described below without removing the suction or discharge pipe or disturbing the alignment of the pump unit:

- Close the suction and discharge gate valves and drain the pump by opening the drain and vent plugs or valves (option).
- Pumps with oil-lubricated bearings: Drain the oil.
- Remove the flushing pipe and any pipes between additional equipment and the pump, if applicable.
- Remove the coupling guard (680.1) and guards (680.2).
- Detach the pump-side coupling half as described in the operating instructions of the coupling in section 9.3.
- Remove the bolts (901.4) between the bearing housings (350.1 and 350.2) and the upper part of the volute casing (102).
- Undo the casing split flange bolts (901.1), detach the upper part of the volute casing (102) from the lower casing half with the aid of the forcing screws and remove it with lifting equipment. Lift the upper part uniformly without tilting it. The interior of the pump (impeller with casing wear rings, shaft seals) is then accessible for inspection.
- In order to lock the mechanical seals (if mounted), engage the discs (550.5) in the groove of the shaft protecting sleeve (524.2) and tighten the bolts (901.3).
- Remove the bolts (901.4) between the bearing housings (350.1 and 350.2) and the lower part of the volute casing (102).

	Caution
	Secure the bearing on the non-driven end against falling down

- Should the non-driven end bearing be a cylindrical roller bearing, the entire bearing housing on the non-driven end (350.2) along with the bearing cover (360) can be removed from the shaft after removing the bolts (901.4).
- Lift the rotor upwards out of the lower casing half. For further disassembly, place it down carefully and secure it in horizontal position against rolling.
- Unscrew the nuts (920.5) for fastening the bearing cover (360) of the floating bearing (non-driven end) and pull off the bearing housing (350.2).
- Loosen the safety screw (914.1), then unscrew the grooved nut (920.4).
- Remove the disc spring (950.2) and the deep groove ball bearing (321) with sleeve (520) from the pump shaft (211).
- Remove the bearing cover (360).
- Remove the V-ring (411.1) from the spacer sleeve (525.1), and the spacer sleeve from the shaft.
- Remove the pump-side coupling half as described in the operating instructions of the coupling in section 9.3.
- Undo the nuts (920.5) for fastening the bearing cover (360) of the locating bearing and pull off the adapter (145) and the bearing housing (350.1).
- Remove the circlip (932) and pull the two angular contact ball bearings (320) off the pump shaft (211). Remove the bearing cover (360).
- Remove the V-ring (411.1) from the spacer sleeve (525.1) and the spacer sleeve from the shaft.

Gland Packing

Unscrew the nuts (920.2) on either side of the gland (452, split), and remove the gland.

Pull out the packing rings with the help of a packing extractor, and pull the shaft protecting sleeve (524.1) out of the shaft seal housing (441).

Mechanical Seal

The two shaft seal housings (441) along with shaft protecting sleeve (524.2), mechanical seal (433) and seal cover (471) can be removed from the shaft as a complete assembly unit, if the locking discs (550.5) are engaged. Unscrew the nuts (920.2) on either side of the seal cover (471) and remove the complete seal cover with mechanical seal and shaft protecting sleeve (524.2) from the shaft seal housing (441).

The impeller (234) has a sliding fit on the shaft and can normally be removed easily. Should there be any difficulty, use a wooden mallet and knock on the hub to loosen the impeller in its fit.

7.4 Reassembly

Reassembly is effected in reverse order to dismantling. For all work on the pump set use the sectional drawing in conjunction with the list of components and the assembly instruction for orientation.

The customary rules of mechanical engineering as well as the instructions for removal and installation of shaft seal, impeller wear rings and casing wear rings (sections 7.5.1 and 7.5.2) must be observed.

The data on cleaning, lubricating and sealing agents given in the assembly instruction must be observed, and the tightening torques indicated must be complied with.

Remove any liquid sealant residues prior to reassembly. O-rings and V-rings must be replaced and their seats on the shaft must be cleaned. In addition, all the sealing elements must be fitted in the components provided for this purpose prior to installation.

For reassembling the rotor, position the pump shaft (211) securely. All fits, threads and sliding fits of the shaft must be cleaned and coated with assembly paste as indicated in the assembly instruction.

Insert the keys required for assembly in the pump shaft (211).

Mount the impeller (234), which has a sliding fit. When fitting the impeller, observe the direction of rotation (see diagram below).

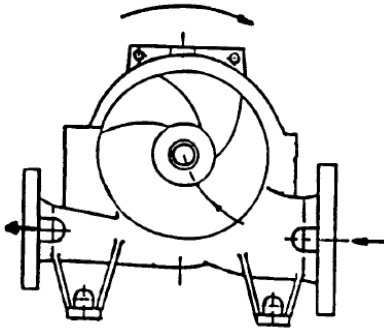

For mounting the casing wear rings (502) and impeller wear rings (503) observe section 7.5.2 "Replacing the casing wear rings and/or impeller wear rings".

Place the casing wear rings on the running surfaces of the impeller. Make sure that the bezels of the rings are on the outside (towards the bearing). Insert the pins required for fixing the casing wear rings.

The remaining components are fitted first on the locating bearing side (i.e. the driven end) of the pump shaft. Slide the spacer sleeve (525.3) over the pump shaft (211).

Slide the shaft seal housing (441) and then the shaft protecting sleeve (524.2) on the shaft.

Gland Packing

Press the packing rings one at a time into the stuffing box chamber with the help of the gland (452, split). Position the butt ends of each ring 90° to 180° away from those of the previous ring. The number of rings and the exact positions of neck ring

(457.1) or lantern ring (458), if mounted, are shown in the sectional drawing. Compression-moulded rings are to be preferred. After fitting all packing rings, mount and tighten the gland lightly, so that the packing rings take on the shape of the stuffing box chamber. Unscrew the gland again to relax the packing.

Mechanical Seal

Mount the mechanical seal in accordance with the manufacturer's instructions in section 9.5 and join it with the shaft protecting sleeve (524.2), seal cover (471) and key (940.5). Then, in order to lock the mechanical seal, engage the discs (550.5) in the groove of the shaft protecting sleeve (524.2) and tighten the bolts (901.3). Insert the unit in the shaft seal housing (441) and fasten it (902.1 and 920.2). Slide the complete assembly unit over the shaft.

Slide the spacer sleeve (525.1) over the shaft, and V-ring (411.1) and bearing cover (360) over the spacer sleeve. Heat the two angular contact ball bearings (320) (max 80°C) and fit them on the pump shaft (211). It is essential to avoid one-sided pressure, e.g. hammer blows, on the outer rings.

Mount the angular contact ball bearings in X-arrangement (face-to-face). It is imperative to ensure that the inner rings of both angular contact ball bearings are seated on each other without an axial clearance.

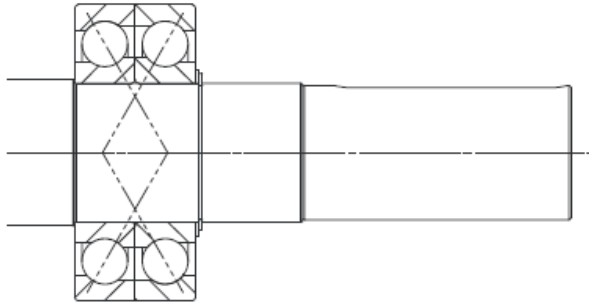

The bearings are secured by the disc (550.1) and the circlip (932).

To fit the spacer sleeve (525.3), shaft seal housing (441) altogether with mechanical seal or gland packing, shaft protecting sleeve (524.1 or 524.2), seal cover (471), spacer sleeve(525.1) and V-ring (411.1) as well as bearing cover (360) at the floating bearing side, proceed as described above for the driven end.

Heat the deep-groove ball bearing (321) to max. 80°C and fit it on the sleeve (520).

Slide the sleeve (520) with deep-groove ball bearing (321) and disc (550.1) on the pump shaft (211) - with the key (940.1) inserted.

	Caution
	It is imperative to observe the instructions on servicing of the bearings given in section 7.2.3. For information on the bearing sizes please refer to the technical annex, section 9.2.

Join the rotor parts elastically with grooved nut (920.4) and disc spring (950.2). For this purpose tighten the disc spring (950.2) as indicated in the following table.

Thread size of grooved nut (920.4)	Tighten by
M55 x 2	1 turn (360 degrees)
M60 x 2	1 turn (360 degrees)
M80 x 2	1 ¼ turns (450 degrees)
M90 x 2	1½ turns (540 degrees)
M100 x 2	1 ½ turns (540 degrees)

	Caution
	This measure is essential to compensate differences in thermal expansion of the pump shaft (211) and the components fitted on it. Then tighten the safety screw (914.1) in order to lock the grooved nut (920.4) in position

The ribs on the shaft seal housings (441) have to be arranged at an angle of 45° or 50° to the top in relation to the horizontal line. The position of the grooved pin (561.2) is then vertically to the bottom.

Prior to inserting the pump rotor in the pump casing, apply a liquid sealant to the surfaces of the casing wear rings and the sealing faces of the shaft seal housing (441) as described in the assembly instruction.

Insert and align the rotor, making sure that the direction of rotation is correct and the grooved pins (561.1 and 561.2) are correctly seated in the casing; see sectional drawing and diagram below.

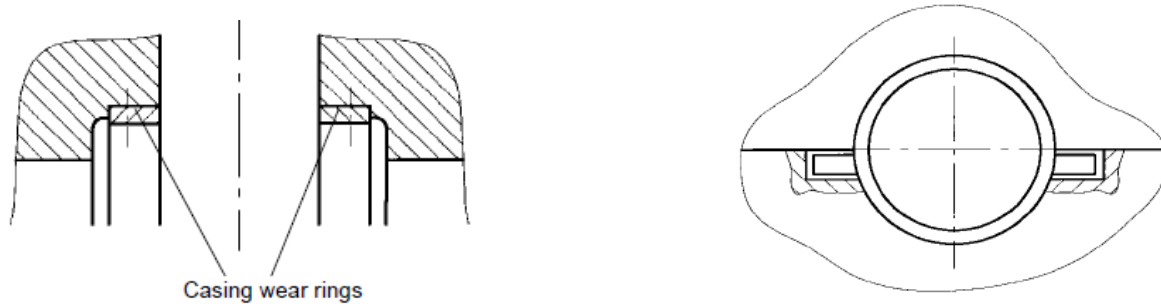

Fasten the bearing housings (350.1 and 350.2) to the lower part of the volute casing (102) by means of the hexagon head bolts (901.4).

Place the V-rings (411.1) in their correct positions, and fit the V-ring (411.2) and adapter (145).

Prior to fitting the upper part of the volute casing (102), clean both casing split flanges meticulously. Apply a thin film of liquid sealant to the entire surface of the lower casing split flange as described in the assembly instruction. Carefully place the upper part of the volute casing in position. Centering is effected by the casing wear rings and the shaft seal housing (441).

Tighten the casing split flange bolts (901.1) in diagonally opposite sequence, starting with the bolts nearest the pump centreline. Fasten the bearing housings (350.1 and 350.2) to the upper part of the volute casing (102) by means of the hexagon head bolts (901.4).

Insert the key (940.3) for fitting the coupling in the pump shaft (211). When fitting the coupling and accessories, observe the individual operating instructions in the sections 9.3, 9.5, and 9.6.

7.5 Instructions for Replacement of Assemblies / Parts

7.5.1 Replacing the Shaft Seal Gland Packing

See the relevant instructions in sections 7.3 and 7.4.

Mechanical Seal

Prior to replacing the mechanical seal, the bearing housings including the rolling elements and the coupling must be removed. Refer to sections 7.3, Dismantling, 7.4 Reassembly, and the operating instructions of the mechanical seal in section 9.5.

7.5.2 Replacing the Casing Wear Rings and /or Impeller Wear Rings

For the impeller clearance please refer to the technical data sheets of the pump in section 9.2.

After dismantling as described in section 7.3.2, the casing wear rings (502) can be removed. When fitting the rings, make sure that their bezels are on the outside (towards the bearing).

The impeller wear rings (503, optional) were shrink fitted on the impeller neck and, in addition, fixed with two grub screws, see assembly instruction.

If the impeller has not been fitted with a wear ring at the factory, and replacing of the casing wear ring alone does not lead to a value near the required impeller clearance (the impeller neck is badly worn by clearance flows), the impeller neck can be turned down in order to fit an impeller wear ring (available as spare part). Alternatively, a new impeller can be supplied.

7.6 Routine Servicing and Inspection Intervals

Interval	Number of personnel required	Time (hours)	Servicing work
Daily	1	1/10	- Check mechanical seal for leakage or leakage rate of gland packing
Weekly	1	1/4	- Check pump operation (suction pressure, discharge head, bearing temperature, noises and vibrations)
Monthly	1	1/4	- Check torsional clearance of the coupling (see operating instructions of the coupling in section 9.3)
	1	1/4	- Switch to stand-by pump, if any, or carry out a test run (for 5 minutes)
Every 4400 (radial ball bearings)/ 2 200 (radial roll bearings operating hours	1	1/4	- Re-lubricate grease-lubricated rolling element bearings (republication quantity, see technical data sheets of pump in section 9.2)
Every 7500 operating hours	1	1/4	- Oil-lubricated rolling element bearings, see section 7.2.3.2
Every 4 years or if discharge head decreases	2	6	- General inspection and overhaul of pump in accordance with the operating instructions. - Check and replace, if required: - wear parts such as bearings, casing wear rings, impeller wear rings, shaft sleeves - impeller and shaft - seal elements

7.7 Supervision Plan

For the exact description of the pump design as well as the pump components and accessories supplied by PUMPIRAN, please refer to section 9 (technical annex) of this instruction manual.

Point to be supervised	Supervisory action	Value to be met
Mechanical seal (if applicable)	Checking the leakage once a week	15 drops/min.
Gland packing (if applicable)	Checking the leakage once a week	10 to 120 drops/min.
Pressure gauge, suction side p_s (if applicable)	Checking the pressure once a week	*
Pressure gauge, discharge side p_d (if applicable)	Checking the pressure once a week	*
Thermometer (suction/discharge nozzle) (if applicable)	Checking the temperature once a week	*
Sight glass, flushing pipe (if applicable)	Checking the flushing water flow once a week	Water is flowing
Vibration measurement (if applicable)	Checking once a week	*
Constant-level oiler, bearing (only oil-lubricated bearings)	Checking the oil level once a week	
Oil level indicator, bearing (if applicable)	Checking the oil level once a week	Min. mark
Bearing temperature (if applicable)	Checking once a week	section 7.2
Connecting coupling (only if oil-lubricated)	Checking the leakage once a week	No leakage permitted
Drive (if applicable)	See the manufacturer's documentation	
Coupling guard	Checking once a month	Must have been mounted without any contact
Earth connection	Checking once a month	Connection must have been made and marking applied

* see list of measuring points (if applicable) in section 9.1 (Pump Set) or interlock criteria in section 9.2 (Pump)

In case of deviations, proceed in accordance with the table in section 8 (Trouble-shooting).

7.8 Spare Parts

7.8.1 Purchasing of Spare Parts

If spare parts are needed, these should be ordered from PUMPIRAN's nearest customer service centre. When ordering spare parts please always quote the following particulars which are stated on the name plate or in the technical data of the pump in section 9.2):

Type series; works/serial number (P-No.) of pump; year of manufacture

The parts ordered should be specified as follows (see sectional drawing and list of spare parts):

Example:

Quantity	Description	Material	Ident. No.	Part No.
1	Rolling element bearing	ST	(8-digit number)	320

7.8.2 Spare Parts Stock

Recommended spare parts stock for 2 years' operation in accordance with VDMA 24296 (also applicable for continuous operation):

Part No.	Description	Number of pumps (incl. stand-by pumps)						
		2	3	4	5	6	8	10 and more
		Quantity of spare parts *						
234	Impeller	-	-	1	1	1	2	30%
502	Casing wear ring	2	2	4	4	6	8	100%
503	Impeller wear ring	2	2	4	4	6	8	100%
	Shaft with keys and shaft nuts	-	-	1	1	1	2	30%
320	Angular contact ball bearing	2	2	4	4	6	8	100%
321	Deep groove ball bearing	1	1	2	2	3	4	50%
524	Shaft protecting sleeve	2	2	4	4	6	8	100%
461	Set of packing rings	8	12	16	20	24	32	400%
	Set of seal elements	4	6	8	8	9	12	150%
433	Mechanical seal	2	2	4	4	6	8	90%
	Spring-loaded ring	2	2	4	4	6	8	90%
	Seat ring	2	2	6	8	10	12	150%
	O-rings	2	2	6	8	10	12	150%
	Seal elements on seat ring Set of springs	1	1	2	2	3	4	50%

* These figures already include those components required twice for replacement

8 Trouble-shooting

8.1 General

The diagram on the right serves to facilitate the understanding of the causes of faults and their remedies. Many faults on pumps have hydraulic causes. The hydraulic behavior of a pump is illustrated by its characteristic curves **H**, **P**, **Eta** and **NPSH** in combination with the system curves **H_A** and **NPSH_A**. The duty point **B** is the intersection of the system curve **H_A** and the pump curve **H**. If it is not possible to determine the cause of the trouble, contact PUMPIRAN's nearest PUMPIRAN customer service centre.

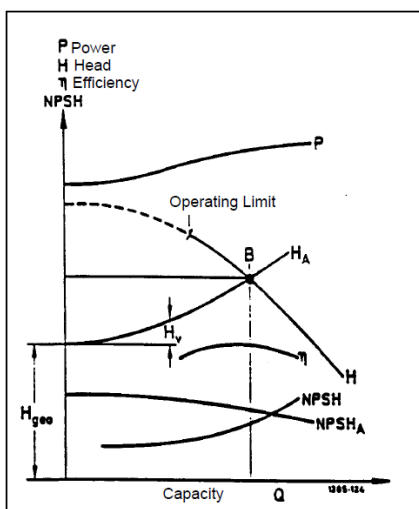

8.2 Causes of Faults and Their Remedies

Faults

Pump discharge pressure too low

Pump discharge pressure too high

Excessive flow rate

Insufficient flow rate

Power consumption is too high

Pump does not deliver

Pump interrupts delivering

Pump runs rough (noise, vibrations)

Impermissible temperature increase at pump casing / shaft seal housing

Bearing temperature too high

Excessive leakage at the shaft seal

Drive is overloaded

Leakage at the pump

												Cause	Remedy				
x	x	x	x	x	x			x	x							Duty point B does not lie at the calculated intersections of Q and H	- Re-adjust the duty point
					x											Pump or piping are not completely vented or primed	- Vent
x			x		x	x	x	x								Supply lines or impeller clogged	- Clean the impeller - Check plant for impurities - Remove deposits in pump and/or piping - Check any strainers installed / suction opening
					x	x	x									Formation of air pockets in the piping	- Correct the suction conditions - Alter the piping
x			x		x	x	x									Suction head is too high (NPSH _{available} is too low) / liquid level is too low	- Check mode of operation - Correct the suction conditions - Increase the suction head - Increase the back pressure by throttling - Install pump at a lower level - Alter the suction / intake piping, if the resistances are too high
x			x		x	x										Air intake at shaft seal	- Clean the sealing liquid line, possibly supply sealing liquid from an external source and/or increase its pressure - Check the liquid level in feed tank - Replace the shaft seal - Replace the shaft protecting sleeve
x			x	x				x								Wrong direction of rotation	- Interchange two of the phases of the power supply - Check the electrical connections - Check the impeller position; correct, if required
X			x					x								Speed is too low	- Increase the speed ¹⁾ - Check the switchgear - Fit a larger impeller ¹⁾

Pump discharge pressure too low
 Pump discharge pressure too high
 Excessive flow rate
 Insufficient flow rate
 Power consumption is too high
 Pump does not deliver
 Pump interrupts delivering
 Pump runs rough (noise, vibrations)
 Impermissible temperature increase at pump casing / shaft seal housing
 Bearing temperature too high
 Excessive leakage at the shaft seal
 Drive is overloaded
 Leakage at the pump

													Cause	Remedy
x			x		x	x							Wear of internal pump parts	<ul style="list-style-type: none"> - Check duty point / pump design - Increase back pressure by throttling - Check medium handled for contamination by chemicals and the solids content - Replace worn components
				x								x	Back pressure is lower than specified in the order	<ul style="list-style-type: none"> - Re-adjust the duty point - Increase the back pressure by throttling
				x								x	Density or viscosity of medium handled is higher than stated in the order	<ul style="list-style-type: none"> - Reduce the speed - In case of permanent overloading, turn down the impeller ¹⁾
	x	x		x				x				x	Speed is too high	<ul style="list-style-type: none"> - Reduce the speed - In case of permanent overloading, turn down the impeller ¹⁾
												x	Tie bolts / seals and gaskets	<ul style="list-style-type: none"> - Check - Tighten the tie bolts - Replace the seals and gaskets - Check pipe connections and secure fixing of the pump; if required, improve the fixing of the piping
												x	Shaft seal is worn	<ul style="list-style-type: none"> - Check flushing / sealing liquid pressure - Clean the sealing liquid line, possibly supply sealing liquid from an external source and/or increase its pressure - Replace the shaft seal - Replace worn components - Replace the shaft protecting sleeve

1) Consult PUMPIRAN

Pump discharge pressure too low
 Pump discharge pressure too high
 Excessive flow rate
 Insufficient flow rate
 Power consumption is too high
 Pump does not deliver
 Pump interrupts delivering
 Pump runs rough (noise, vibrations)
 Impermissible temperature increase at pump casing / shaft seal housing
 Bearing temperature too high
 Excessive leakage at the shaft seal
 Drive is overloaded
 Leakage at the pump

													Cause	Remedy
x			x										Unfavorable flow to suction nozzle of pump	- Alter the piping - If required, alter the suction / inlet pipe, if the resistances are too high - Check the piping layout for swirl or irregular flow profile (e.g. downstream of an elbow)
													Gland follower, seal cover (mech. seal) have been tightened incorrectly; wrong packing material	- Alter - Replace - Correct - Replace the gland packing - Replace worn components
													Lack of cooling liquid or dirty cooling liquid chamber	- Check flushing / sealing liquid pressure - Clean the sealing liquid line, possibly supply sealing liquid from an external source and/or increase its pressure - Increase the cooling liquid flow rate - Purify/clean the cooling liquid
													Pump is warped or sympathetic vibrations in piping	- Re-align the pump / drive - Check pipe connections and secure fixing of the pump; if required, improve the fixing of the piping - Take vibration-damping measures
													Increased axial thrust	- Check the duty point / pump design - Check mode of operation - Check suction flow
													Insufficient or excessive quantity of lubricant	- Clean the bearing - Top up, reduce or change lubricant
x			x	x									Motor is running on two phases only	- Replace defective fuses - Check the electrical cable connections - Check the switchgear

Pump discharge pressure too low
 Pump discharge pressure too high
 Excessive flow rate
 Insufficient flow rate
 Power consumption is too high
 Pump does not deliver
 Pump interrupts delivering
 Pump runs rough (noise, vibrations)
 Impermissible temperature increase at pump casing / shaft seal housing
 Bearing temperature too high
 Excessive leakage at the shaft seal
 Drive is overloaded
 Leakage at the pump

											Cause	Remedy					
											x	x	x			Unbalance of rotor	- Clean the rotor - Check for run-out; re-align, if required - Re-balance the rotor
											x	x	x			Defective bearings	- Replace
																Insufficient flow rate	- Re-adjust the duty point - Fully open the shut-off element in the suction / inlet pipe - Fully open the shut-off element in the discharge pipe - Calculate or measure the hydraulic losses H _v
											x					On star-delta starting, the motor does not succeed in reaching the delta stage	- Check the electrical cable connections - Check the switchgear
											x					Impermissible air or gas content in medium pumped	- Vent - Check integrity of suction pipe; seal, if required
											x					Air intake at pump inlet	- Correct the suction conditions - Reduce the flow velocity at the suction pipe inlet - Increase the suction head - Check integrity of suction pipe; seal, if required - Replace defective pipes
																Cavitation (rattling noise)	- Correct the suction conditions - Check mode of operation - Increase the suction head - Install pump at a lower level
																Foundation not rigid enough	- Check - Alter
											x					Impermissible parallel operation	- Re-adjust the duty point - Alter the pump characteristic H ¹⁾
																Shaft run-out	- Replace the shaft
																Impeller rubs against casing components	- Check the rotor - Check the impeller position - Check whether pipe connections are free from stresses or strains

**Head office**

First Floor, Eskan Second Tower, Mirdamad Intersection,
Vali-e-Asr Ave., Tehran-Iran

Tel: +98 21 88 65 48 10-14

Fax: +98 21 88 79 89 42

Factory

P.O.Box: 51845-135 Tabriz- Iran

Tel: +98 41 32 89 06 44-8

Fax: +98 41 32 89 84 46

Marketing and Sale Office

Tel: +98 411 32 89 07 07-8, 32 89 04 11

Fax: +98 411 32 87 22 33

sales@pumpiran.com

Sale Engineering

Tel: +98 41 32 88 12 86

Fax: +98 41 32 87 22 33

sale_eng@pumpiran.com

www.pumpiran.com